

MINIFIX-04-SCLDR

Innenausdrehen ab
 Internal boring from
 Alésage intérieur

Ø4,8mm

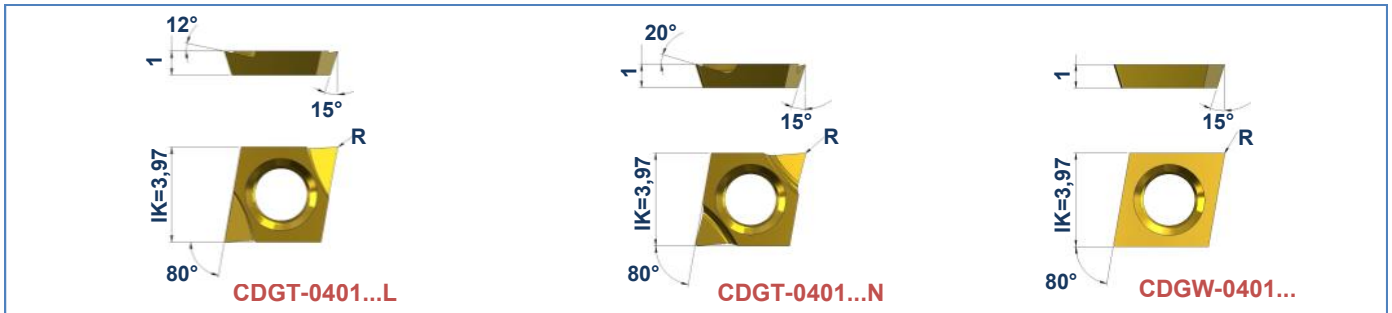
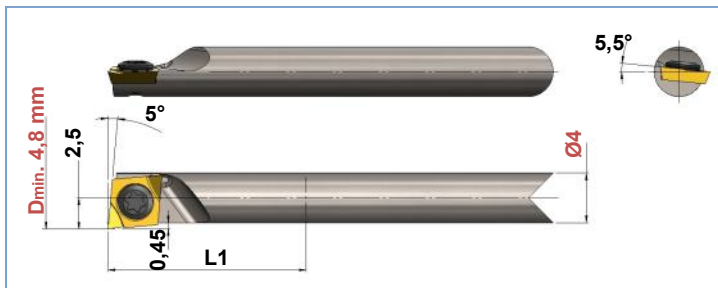
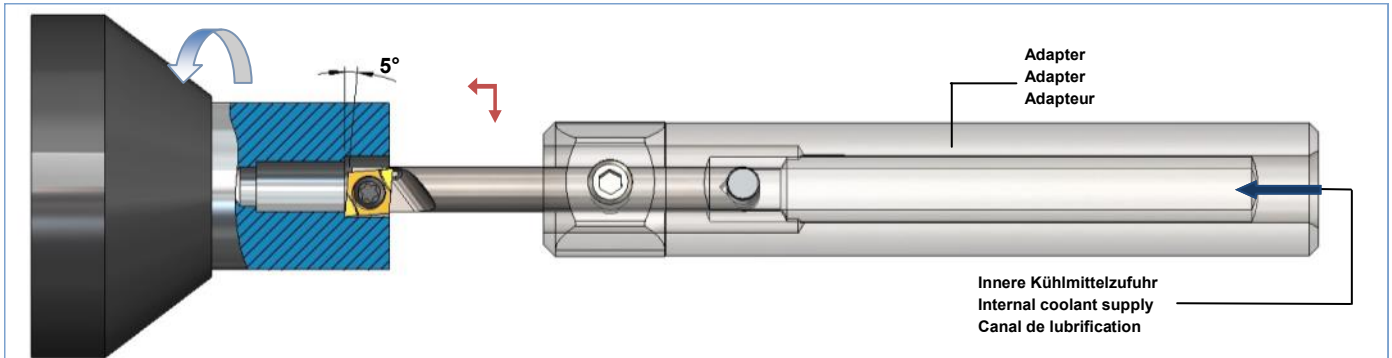

1			2	3	
Art. Nr. Item no. No. d'art.	Best. Nr. Ref. no. Réf.	L1		Art. Nr. Item no. No. d'art.	Best. Nr. Ref. no. Réf.
166985	MFE-04-SCLDR-11-HM (HM-Schaft/Carbide shank/Tige en carbure)	11	CD...0401... Seite/Page: 23	168434	SD-1830-T5
166986	MFE-04-SCLDR-15-HM (HM-Schaft/Carbide shank/Tige en carbure)	15			
166987	MFE-04-SCLDR-19-HM (HM-Schaft/Carbide shank/Tige en carbure)	19			
166973	MFE-04-SCLDR-11-ST (Werkzeugstahl/Tool steel/Acier à outils)	11			
166974	MFE-04-SCLDR-15-ST (Werkzeugstahl/Tool steel/Acier à outils)	15			
166975	MFE-04-SCLDR-19-ST (Werkzeugstahl/Tool steel/Acier à outils)	19			

Andere Abmessungen, linke Ausführungen und Beschichtungen auf Anfrage

Other dimensions, left versions and Coatings on request / Autres dimensions, exécution gauche et Revêtements sur demande

CD...0401...

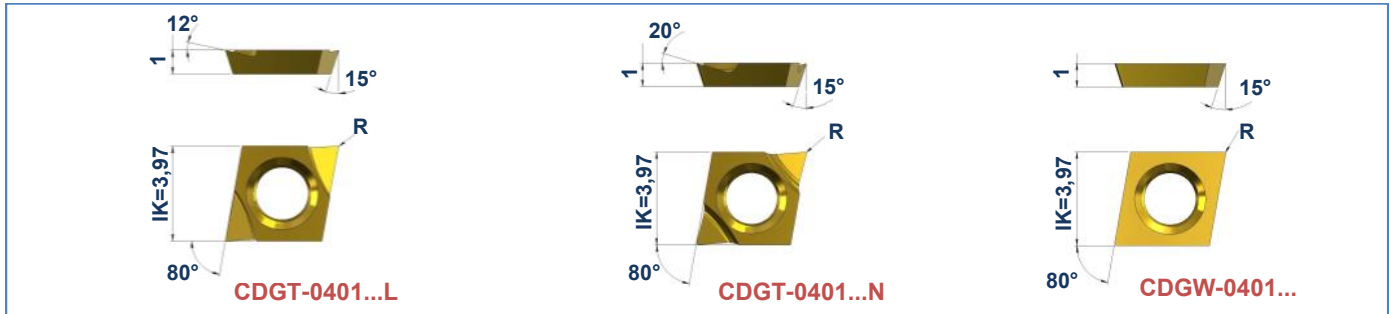

Art. Nr. Item no. No. d'art.	Best. Nr. Ref. no. Réf.	R	Beschichtung Coating Revêtement
167566	CDGT-040100-L-G1A-K10	-	-
169934	CDGT-040100-L-G1A-BD1	-	BD1
167567	CDGT-040101-L-G1A-K10	0,1	-
169935	CDGT-040101-L-G1A-BD1	0,1	BD1
167568	CDGT-040102-L-G1A-K10	0,2	-
169937	CDGT-040102-L-G1A-BD1	0,2	BD1
167569	CDGT-040104-L-G1A-K10	0,4	-
169938	CDGT-040104-L-G1A-BD1	0,4	BD1
167870	CDGT-040101-N-G1A-K10	0,1	-
169939	CDGT-040101-N-G1A-BD1	0,1	BD1
167871	CDGT-040102-N-G1A-K10	0,2	-
169940	CDGT-040102-N-G1A-BD1	0,2	BD1
167872	CDGT-040104-N-G1A-K10	0,4	-
169941	CDGT-040104-N-G1A-BD1	0,4	BD1
167863	CDGW-040100-N-G1A-K10	-	-
169942	CDGW-040100-N-G1A-BD1	-	BD1
167864	CDGW-040101-N-G1A-K10	0,1	-
169943	CDGW-040101-N-G1A-BD1	0,1	BD1
167865	CDGW-040102-N-G1A-K10	0,2	-
169944	CDGW-040102-N-G1A-BD1	0,2	BD1
167866	CDGW-040104-N-G1A-K10	0,4	-
169945	CDGW-040104-N-G1A-BD1	0,4	BD1

Andere Abmessungen, linke Ausführungen und Beschichtungen auf Anfrage

Other dimensions, left versions and Coatings on request / Autres dimensions, exécution gauche et Revêtements sur demande